

# SmoothSlide



Discover best-in-class sliding wardrobe fittings with SmoothSlide from Sleek.



STELLAR



ADVANCE

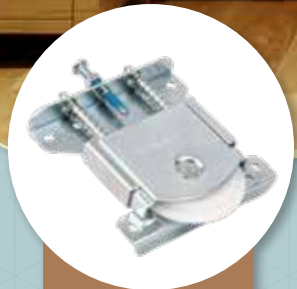

SMART

**Sleek** by  **asianpaints**  
WARDROBE COMPONENTS

# Everything you need for a **Smooth Slide.**



How good your sliding wardrobe is depends on the hardware components you choose. Sleek SmoothSlide offers modern, futuristic and intuitive hardware solutions and gives your sliding wardrobe the upgrade it truly deserves.

Go From  
**SWINGING**



To **SLIDING**

Sliding wardrobes are a popular choice because they have plenty of advantages compared to other types of wardrobes.



**Sleek  
Modern Look**



**Saves  
Space**



**Soft  
Closing**



**More  
Internal Space**



**Value for  
Money**

**Sleak** by **Asianpaints**  
WARDROBE COMPONENTS

— SAY HELLO TO THE —

# SmoothSlide

## FAMILY

STELLAR



SLIM



ADVANCE



SMART DOME

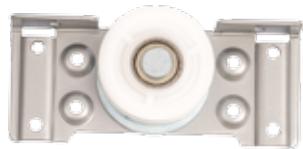

SMART



STANDARD DOME



STANDARD



Easy  
installation



Tested for  
50,000 cycles



Robust  
built quality



5 years  
warranty\*



Precise  
adjustment



Great  
aesthetics

5 years functional warranty  
1 year surface warranty

**Slazak** by **opasianpaints**  
WARDROBE COMPONENTS

# SmoothSlide

STELLAR



These highly premium hardware fittings come with cutting-edge technology and are designed for large 2 and 3 shutter wardrobes.

# Stellar Two Door Kit



Note : Suitable for both wooden and aluminum profile doors

## Features & Benefits

### Superior Overlay Fitting

Load bearing capacity up to 80 kgs



### Door Thickness Range

18 to 40 mm range



### Soft Closing Damper

Up to 80 kgs (Heavy Duty Damper)



### Height Adjustment

Up to 8 mm



### Adaptable Track

Twin track in 2.4 and 3.6 m



### Maximum Door Width

Up to 1500 mm (for wider doors)



### Self Cleaning Rollers

Prevent dust accumulation for longer life



### Two Way Soft Closing

Soft opening and soft closing



### Safe Anti-Jump Function

For stable functioning



### Finish

Metallic Grey

Scan for Installation Video



# Stellar Three Door Kit



Note : Suitable for both wooden and aluminum profile doors

- Features and Benefits similar to Stellar Two Door Kit
- With optional Centro Damper the center door opens on either side with soft close function
- Without Centro Damper the center door opens only on the left or right with soft close function

Scan for Installation Video



# HARDWARE

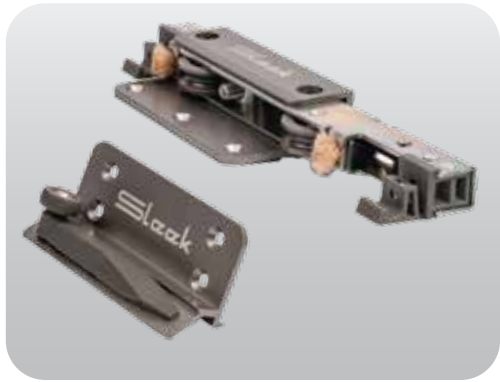

Inner Door Fitting

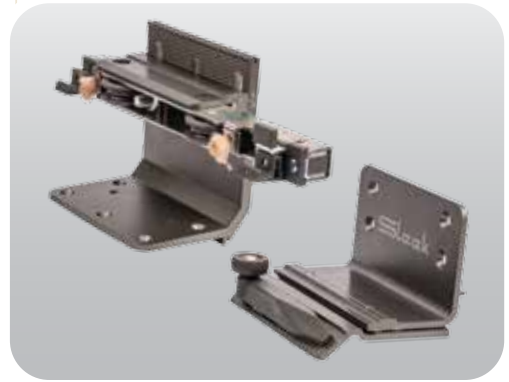

Outer Door Fitting



Soft Closing Damper



Centro Soft Closing Damper

\*For Three Door Kit only.  
Order Separately.

# TRACKS



Top Track



Bottom Track





# SmoothSlide

SLIM

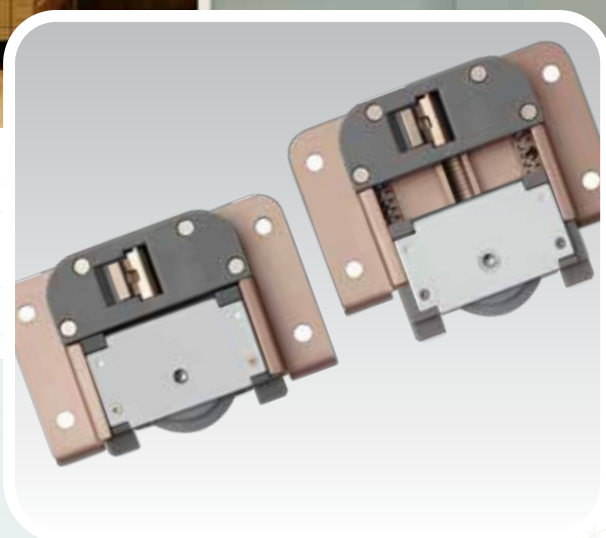







These are a popular choice and are a good option if you're looking for premium sliding wardrobes.

# Slim Two Door Kit



## Features & Benefits

|  |   |
|--|---|
| <p><b>Superior Surface Fitting</b><br/>Load bearing capacity up to 45 kgs</p>                         | <p><b>Maximum Door Width</b><br/>1200 mm</p>   |
| <p><b>Height Adjustment</b><br/>Up to 10 mm</p>   | <p><b>Finish</b><br/>Rose Gold</p>   |
| <p><b>Soft Closing Damper</b><br/>Up to 45 kgs</p>    | <p><b>Two Way Soft Closing</b><br/>Soft opening and soft closing</p>   |
| <p><b>Integrated Damper</b><br/>For neat and clean look</p>   | <p><b>Safe Anti-Jump Function</b><br/>For stable functioning</p>   |
| <p><b>Door Thickness</b><br/>• 18 to 36 mm (for single track)<br/>• 18 to 21 mm (for twin track)</p>  | <p><b>Adaptable Tracks</b></p> <ul style="list-style-type: none"> <li>• Single track in 2.4, 3 and 3.6 m</li> <li>• Twin track in 2.4, 3 and 3.6 m</li> </ul>  |

Scan for Installation Video



# HARDWARE

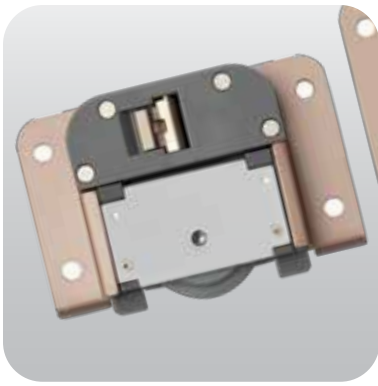

Top & Bottom Wheel



Soft Closing Damper

# TRACKS

## Single Track



Top & Bottom Track

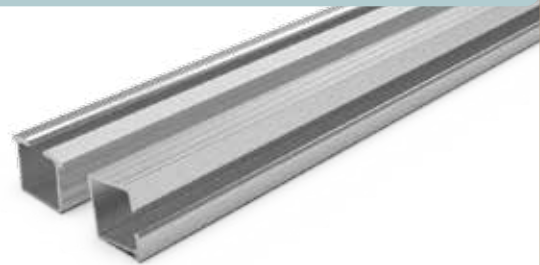

## Twin Track



Top Track

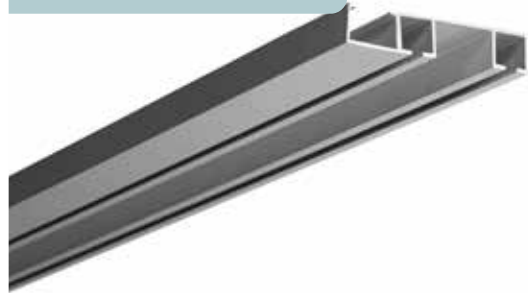

Bottom Track



# SmoothSlide ADVANCE



These hardware fittings are a good option if you're looking for premium sliding wardrobes with large 2 and 3 door shutters.

# Advance Two Door Kit

One Door Kit

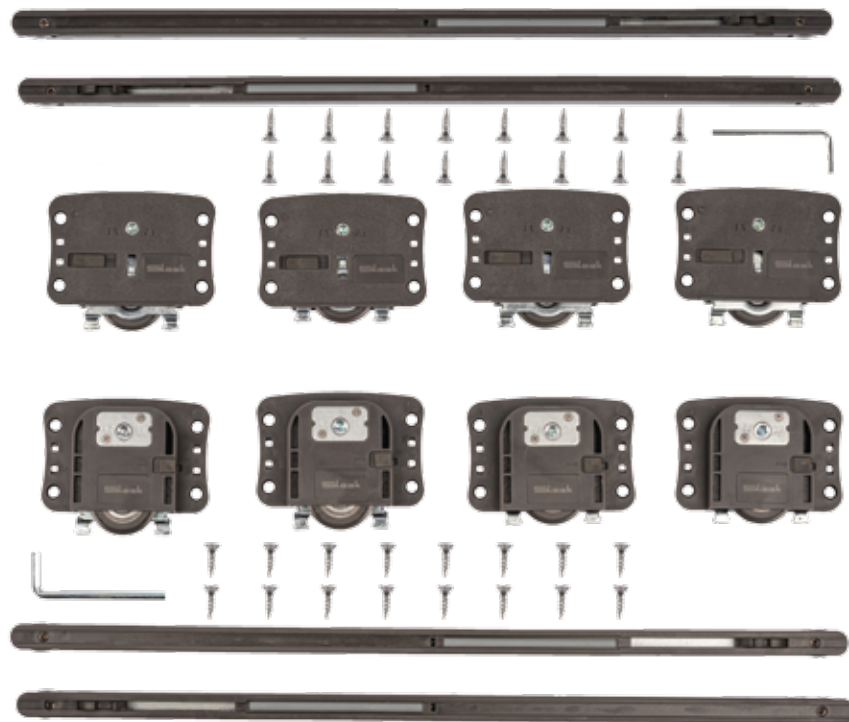

Note : Suitable for both wood and aluminum profile doors. To create a Three Door Wardrobe with Advance, purchase One Door Kit + Two Door Kit.

## Features & Benefits

### Superior Reversible Fitting

- Load bearing capacity up to 50 kgs
- Both surface and concealed installation possible



### Soft Closing Damper

Up to 50 kgs



### Height Adjustment

+/- 2 mm



### Maximum Door Width

1500 mm



### Integrated Damper

For neat and clean look



### Door Thickness

- 18 to 36 mm (for single track)
- 18 to 21 mm (for twin track)
- 18 to 25 mm (Groove Style Fitting)



### Two Way Soft Closing

Soft opening and soft closing



### Safe Anti-Jump Roller

For stable functioning



### Finish

Grey



### Adaptable Tracks

- Single track in 2.4, 3 and 3.6 m
- Twin track in 2.4, 3 and 3.6 m



Scan for Installation Video



# HARDWARE



Top & Bottom Wheel



Soft Closing Damper

# TRACKS

## Single Track



Top & Bottom Track

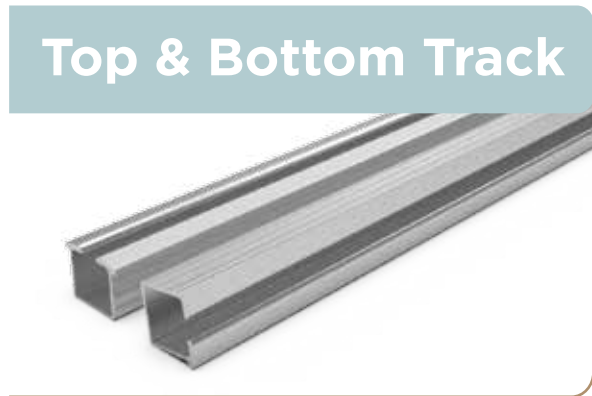

## Twin Track



Top Track

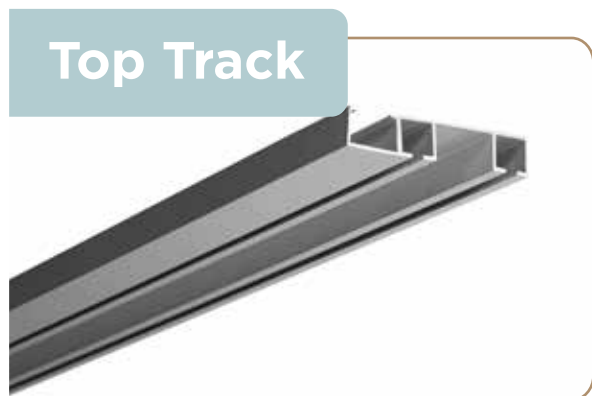

Bottom Track



# SmoothSlide

SMART DOME



High quality and very low on maintenance, these hardware fittings are good for sliding wardrobes of all kinds.

# Smart Dome One Door Kit

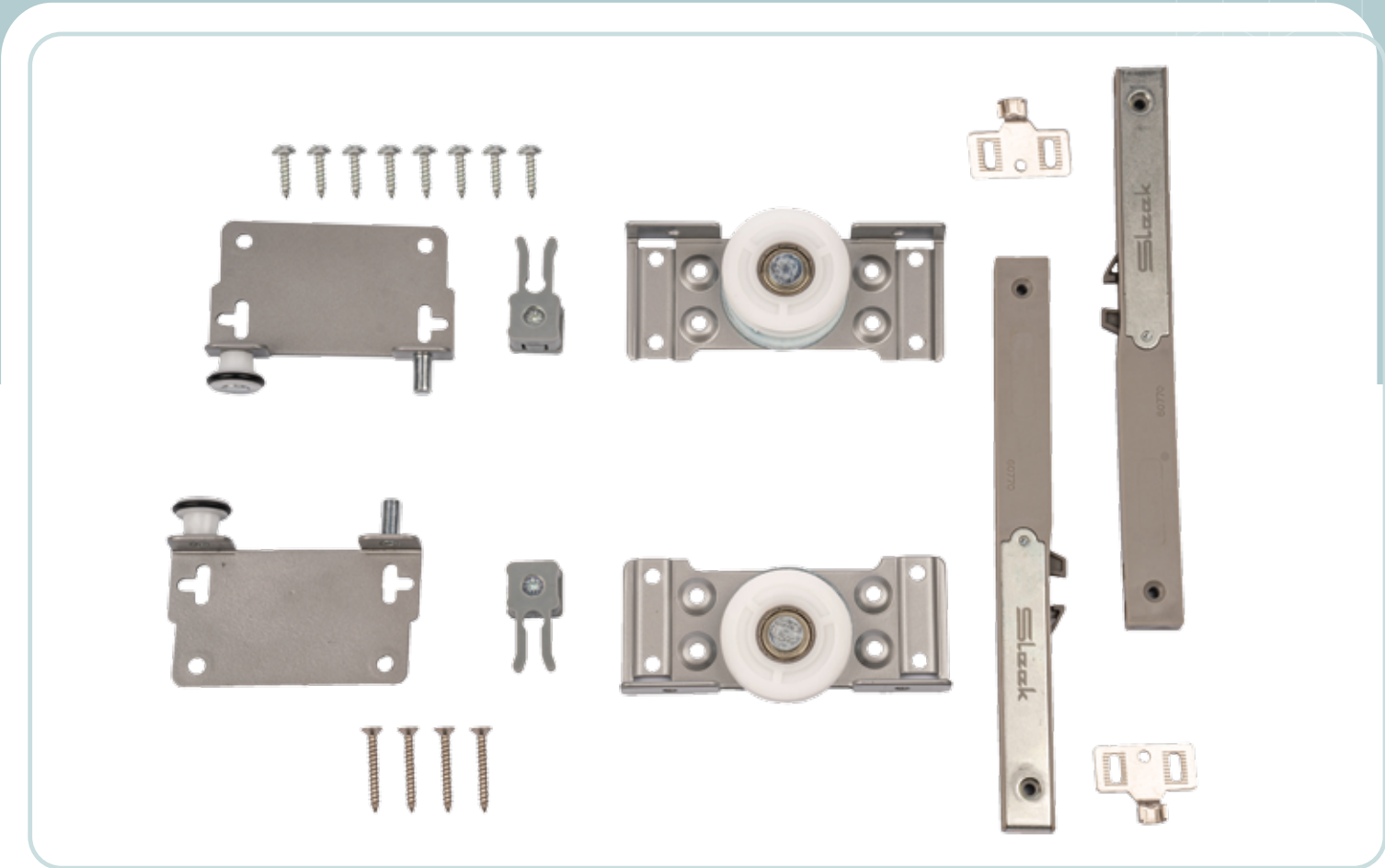

## Features & Benefits

### Superior Concealed Fitting

Load bearing capacity up to 50 kgs



### Soft Closing Damper

Up to 50 kgs



### Height Adjustment

Up to 2 mm



### Maximum Door Width

1200 mm



### Door Thickness

- 18 to 36 mm (for single track)
- 18 to 25 mm (for twin track)



### Optional Soft Closing

- One side soft opening
- Both sides soft closing and opening



### Surface Damper

Easy installation with 100% opening access



### Bottom Dome Track

Zero dust accumulation



### Finish

Metallic Grey



### Adaptable Tracks

- Single track in 2.4, 3 and 3.6 m
- Twin track in 2.4, 3 and 3.6 m

Scan for Installation Video





# HARDWARE

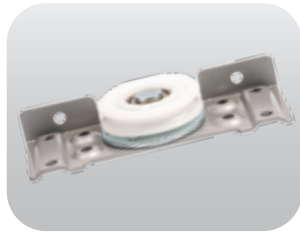

Bottom Wheel



Top Guide

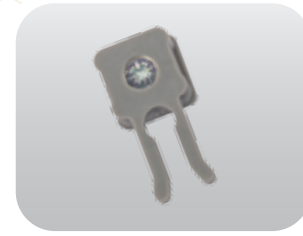

Lock Clip

# TRACKS

## Single Track



Top Track



Bottom Track



## Twin Track

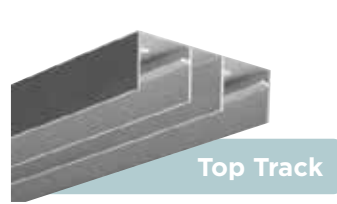

Top Track



Bottom Track



# SOFT CLOSING DAMPER



- » Set of 2 Dampers with activating clip for 1 Door
- » Load bearing capacity up to 50 kgs
- » Quick Installation - Surface type fitting



# SmoothSlide

SMART



These highly intuitive hardware fittings are very easy to install and are best suited for full size bedroom wardrobes.

# Smart One Door Kit

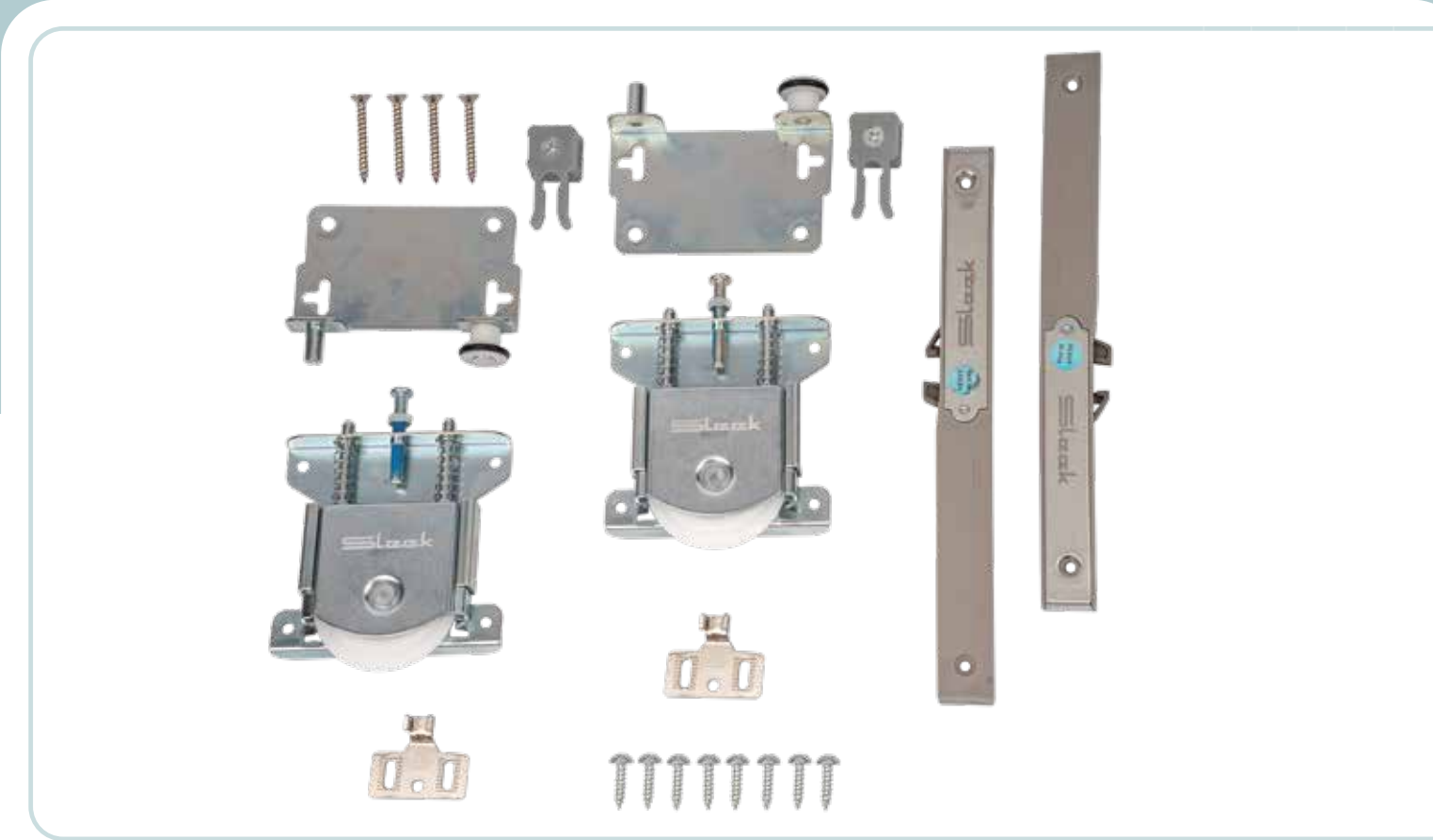

## Features & Benefits

**Superior Surface Fitting**  
Load bearing capacity up to 50 kgs

**Door Thickness**  
18 to 21 mm (for twin track)

**Soft Closing Damper**  
Up to 50 kgs

**Height Adjustment**  
Up to 10 mm

**Adaptable Tracks**  
Twin track in 2.4, 3 and 3.6 m

**Maximum Door Width**  
1200 mm

**Surface Damper**  
Easy installation with 100% opening access

**Safe Anti-Jump Roller**  
For stable functioning

**Finish**  
Zinc Plated

**Optional Soft Closing**

- One side soft opening
- Both sides soft opening and closing

Scan for Installation Video



# HARDWARE

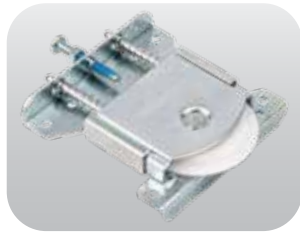

Bottom Wheel



Top Guide

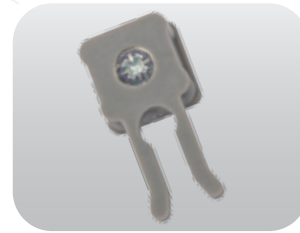

Lock Clip

# TRACKS



Top Track



Bottom Track

# SOFT CLOSING DAMPER



- » Set of 2 Dampers with activating clip for 1 Door
- » Load bearing capacity up to 50 kgs
- » Quick Installation - Surface type fitting



# SmoothSlide

STANDARD DOME



These premium hardware fittings are sleek, durable, sturdy and are best suited for a sliding wardrobe designed for kids.

# Standard Dome One Door Kit



## Features & Benefits

**Superior Concealed Fitting**  
Load bearing capacity up to 35 kgs



**Door Thickness**  
18 to 21 mm (for single track)



**Soft Closing Damper**  
Up to 35 kgs



**Height Adjustment**  
+/- 2 mm



**Adaptable Tracks**  
Single track in 2.4, 3 and 3.6 m



**Maximum Door Width**  
1000 mm



**Surface Damper**  
Easy installation with 100% opening access



**Bottom Dome Track**  
Zero dust accumulation



**Finish**  
Zinc Plated



**Optional Soft Closing**

- One side soft opening
- Both sides soft opening and closing



Scan for Installation Video



## HARDWARE



Bottom Wheel



Top Guide



Lock Clip

## TRACKS



Top Track



Bottom Track

## SOFT CLOSING DAMPER



- » Set of 2 Dampers with activating clip for 1 Door
- » Load bearing capacity up to 35 kgs
- » Quick Installation - Surface type fitting



# SmoothSlide

STANDARD



Easy on the pocket, these hardware fittings are best suited for TV, kids wardrobe and shoe units.



# Standard One Door Kit

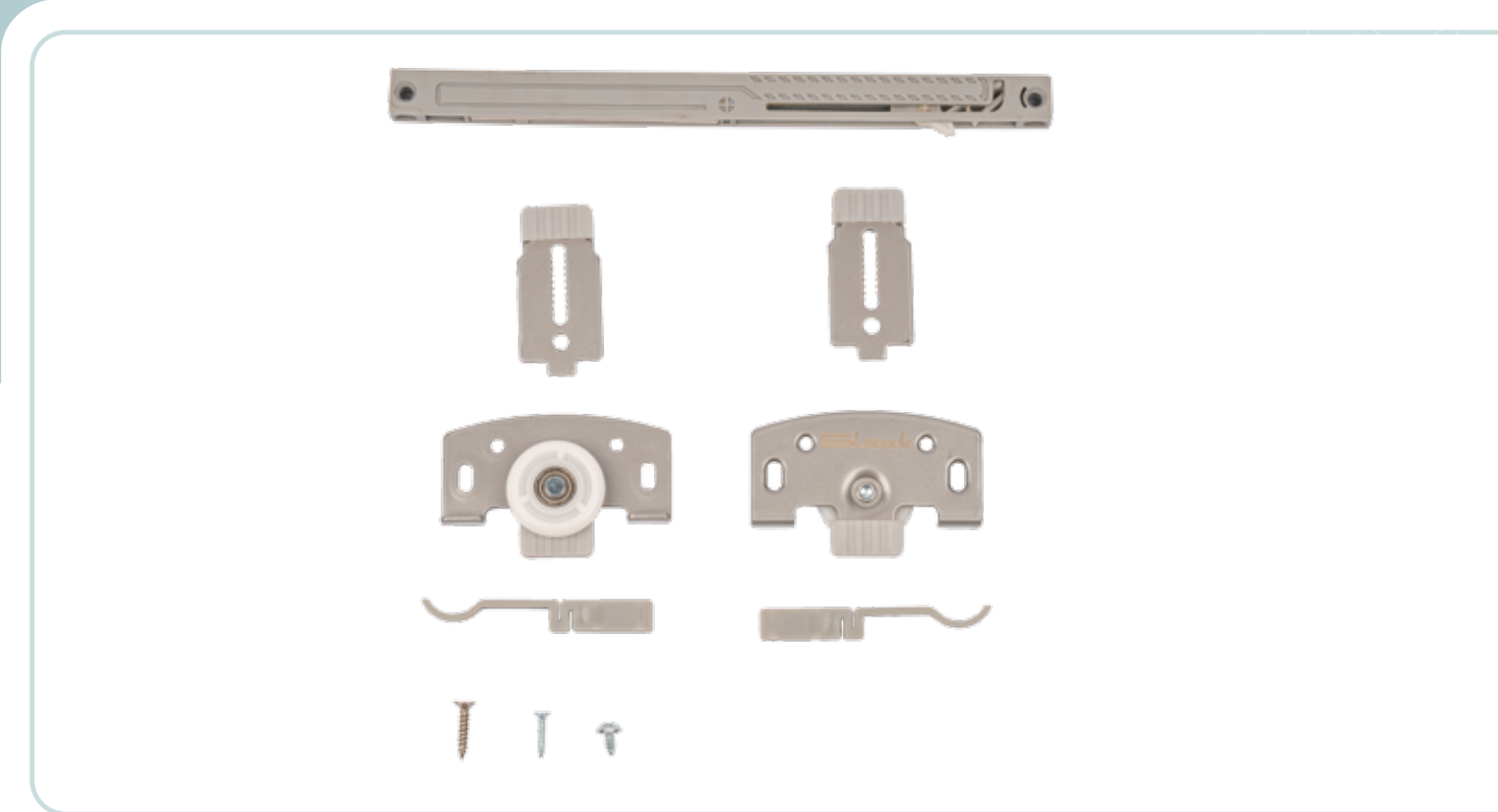

## Features & Benefits

**Superior Concealed Fitting**  
Load bearing capacity up to 35 kgs



**Door Thickness**  
18 to 21 mm (for single track)



**Soft Closing Damper**  
Up to 35 kgs



**Height Adjustment**  
Up to 2 mm



**Adaptable Tracks**  
Single track in 2.4, 3 and 3.6 m



**Maximum Door Width**  
1000 mm



**Surface Damper**  
Easy installation with 100% opening access



**Universal Track**  
Same track for top and bottom



**Finish**  
Metallic Grey



**Optional Soft Closing**

- One side soft opening
- Both sides soft opening and closing



Scan for Installation Video



## HARDWARE



Bottom  
Wheel

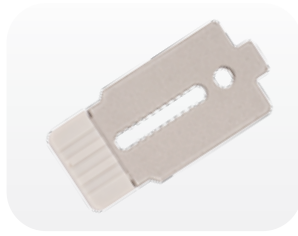

Top  
Guide

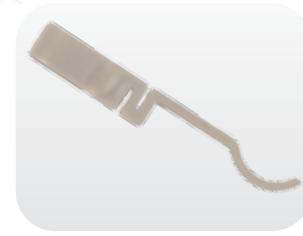

Lock  
Clip

## TRACKS



## SOFT CLOSING DAMPER



- » Set of 2 Dampers with activating clip for 1 Door
- » Load bearing capacity up to 35 kgs
- » Quick Installation - Surface type fitting



# Things to keep in mind during installation.



Do not exceed recommended door weight

---



Do not exceed recommended door thickness for twin track

---



Keep all hardware and tools handy and in close proximity

---



Be careful during installation

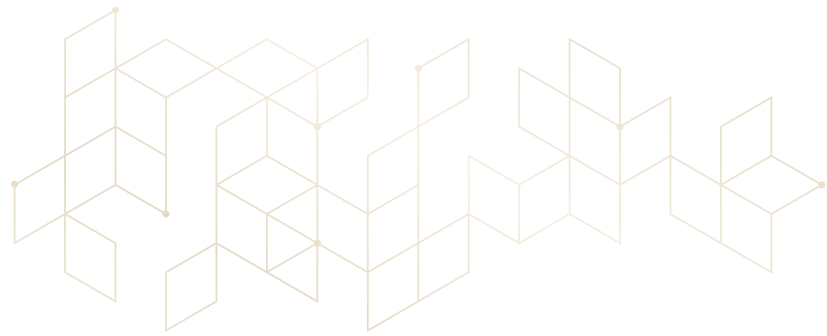

# An Important note on dampers.



While dampers come as part of the regular package for SmoothSlide Advance, SmoothSide Slim and SmoothSlide Stellar, they are also a great fit for the SmoothSlide Standard and Smart range and can be purchased separately.

## Features



Longer soft close travel distance

---



Two-way soft closing dampers available

---



Ideal for door weight between 35-80 kg







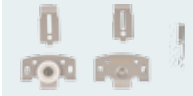

### **Warranty Terms & Conditions :**

1. Warranty covers the defects resulting from defective parts, materials or manufacturing, if such defects revealed during the period of warranty from the date of purchase.
2. Repairs, installations and removal of product shall be carried out only by an authorized service personnel, failing which this warranty will be void.
3. Breakage of plastic part not covered under warranty.
4. Installation to be done as per manual provided with the product
5. Improper installation, not as per instructions will make the warranty null and void.
6. Warranty covers manufacturing defects and will not cover any defects arising out of factors which are out of control of the company as indicated below.
  - Damage resulting from normal wear and tear, scratches, dent etc. developed over time due to usage.
  - Surface damages and color fading due to improper cleaning practices including but not limited to the use of bleach, alkali, acid cleaners, dry (powder) cleaners or any other abrasive cleaners.
  - Damage due to exposure to acids, chemicals or improper maintenance and failure to clean which may lead to issues like scaling & gloss reduction.
  - Use of excessive force or damage resulting from use of sharp objects like tools.
7. Rusting not covered under warranty.

**Maintenance Tip : Clean using only water with soft cloth/sponge**

# SMOOTHSLIDE - PRICE LIST



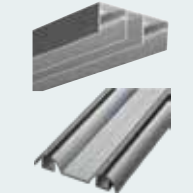

| Product Code | Product Description                                     | Product Image   | MRP ₹ |
|--------------|---|---|-------|
| HIWFSTAND1   | SMOOTH SLIDE STANDARD - 1 DOOR SET                      |  | 400   |
| HIWFSTANSC   | SMOOTH SLIDE STANDARD SOFT CLOSE SYSTEM (SET OF 2 PCS.) |  | 1000  |
| HLWTSTAN24S  | SMOOTH SLIDE STANDARD TRACK 2.44m SINGLE                |  | 600   |
| HLWTSTAN30S  | SMOOTH SLIDE STANDARD TRACK 3m SINGLE                   |   | 750   |
| HLWTSTAN36S  | SMOOTH SLIDE STANDARD TRACK 3.66m SINGLE                |   | 900   |

| Product Code | Product Description   | Product Image   | MRP ₹ |
|--------------|---|---|-------|
| HIWFSTADO1   | SMOOTH SLIDE STANDARD DOME - 1 DOOR SET                           |  | 425   |
| HIWFSTANSC   | SMOOTH SLIDE STANDARD SOFT CLOSE SYSTEM (SET OF 2 PCS.)           |  | 1000  |
| HLWTSTDO24S  | SMOOTH SLIDE STANDARD DOME SET OF TOP & BOTTOM TRACK 2.44m SINGLE |  | 975   |
| HLWTSTDO30S  | SMOOTH SLIDE STANDARD DOME SET OF TOP & BOTTOM TRACK 3m SINGLE    |   | 1215  |
| HLWTSTDO36S  | SMOOTH SLIDE STANDARD DOME SET OF TOP & BOTTOM TRACK 3.66m SINGLE |   | 1470  |

| Product Code | Product Description                                     | Product Image   | MRP ₹ |
|--------------|---|---|-------|
| HIWFSMART1   | SMOOTH SLIDE SMART - 1 DOOR SET                         |  | 850   |
| HIWFSMARTSC  | SMOOTH SLIDE SMART CLOSE SYSTEM (SET OF 2 PCS.)         |  | 1300  |
| HLWTSMRT24T  | SMOOTH SLIDE SMART SET OF TOP & BOTTOM TRACK 2.44m TWIN |  | 3000  |
| HLWTSMRT30T  | SMOOTH SLIDE SMART SET OF TOP & BOTTOM TRACK 3m TWIN    |   | 3750  |
| HLWTSMRT36T  | SMOOTH SLIDE SMART SET OF TOP & BOTTOM TRACK 3.66m TWIN |   | 4500  |

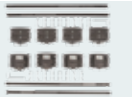

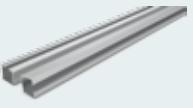
# SMOOTHSLIDE - PRICE LIST

| Product Code | Product Description  | Product Image  | MRP ₹ |
|--------------|--|--|-------|
| HIWFSDOT1    | SMOOTH SLIDE SMART DOME - 1 DOOR SET                           |   | 900   |
| HIWFSMARSC   | SMOOTH SLIDE SMART CLOSE SYSTEM (SET OF 2 PCS.)                |   | 1300  |
| HLWTSMD024S  | SMOOTH SLIDE SMART DOME SET OF TOP & BOTTOM TRACK 2.44m SINGLE |   | 1425  |
| HLWTSMD030S  | SMOOTH SLIDE SMART DOME SET OF TOP & BOTTOM TRACK 3m SINGLE    |  | 1740  |
| HLWTSMD036S  | SMOOTH SLIDE SMART DOME SET OF TOP & BOTTOM TRACK 3.66m SINGLE |  | 2370  |
| HLWTSMD024T  | SMOOTH SLIDE SMART DOME SET OF TOP & BOTTOM TRACK 2.44m TWIN   |  | 2700  |
| HLWTSMD030T  | SMOOTH SLIDE SMART DOME SET OF TOP & BOTTOM TRACK 3m TWIN      |  | 3300  |
| HLWTSMD036T  | SMOOTH SLIDE SMART DOME SET OF TOP & BOTTOM TRACK 3.66m TWIN   |  | 4050  |

| Product Code | Product Description                                       | Product Image   | MRP ₹ |
|--------------|---|---|-------|
| HIWFADVSC2   | SMOOTH SLIDE ADVANCE WITH SOFT CLOSE - 2 DOOR SET         |  | 4500  |
| HIWFADVSC1   | SMOOTH SLIDE ADVANCE WITH SOFT CLOSE - 1 DOOR SET         |  | 2300  |
| HLWTADSM24S  | SMOOTH SLIDE ADVANCE SLIM TRACK 2.44m SINGLE              |  | 650   |
| HLWTADSM30S  | SMOOTH SLIDE ADVANCE SLIM TRACK 3m SINGLE                 |   | 775   |
| HLWTADSM36S  | SMOOTH SLIDE ADVANCE SLIM TRACK 3.66m SINGLE              |   | 950   |
| HLWTADVN24T  | SMOOTH SLIDE ADVANCE SET OF TOP & BOTTOM TRACK 2.44m TWIN |  | 3800  |
| HLWTADVN30T  | SMOOTH SLIDE ADVANCE SET OF TOP & BOTTOM TRACK 3m TWIN    |   | 4600  |
| HLWTADVN36T  | SMOOTH SLIDE ADVANCE SET OF TOP & BOTTOM TRACK 3.66m TWIN |   | 5650  |

# SMOOTHSLIDE - PRICE LIST

| Product Code | Product Description  | Product Image  | MRP ₹ |
|--------------|--|--|-------|
| RMWRH190     | SmoothSlide Slim - 2 Door Set                                  |   | 4520  |
| HLWTADSM24S  | SMOOTH SLIDE ADVANCE SLIM TRACK 2.44m SINGLE                   |   | 650   |
| HLWTADSM30S  | SMOOTH SLIDE ADVANCE SLIM TRACK 3m SINGLE                      |  | 775   |
| HLWTADSM36S  | SMOOTH SLIDE ADVANCE SLIM TRACK 3.66m SINGLE                   |  | 950   |
| HLWTADSM24T  | SMOOTH SLIDE ADVANCE SLIM SET OF TOP & BOTTOM TRACK 2.44m TWIN |  | 3750  |
| HLWTADSM30T  | SMOOTH SLIDE ADVANCE SLIM SET OF TOP & BOTTOM TRACK 3m TWIN    |  | 4575  |
| HLWTADSM36T  | SMOOTH SLIDE ADVANCE SLIM SET OF TOP & BOTTOM TRACK 3.66m TWIN |  | 5625  |

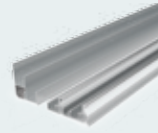
| Product Code | Product Description                                       | Product Image   | MRP ₹ |
|--------------|---|---|-------|
| HIWFSTRSC2   | SMOOTH SLIDE STELLAR WITH SOFT CLOSE - 2 DOOR SET         |  | 17000 |
| HIWFSTRSC3   | SMOOTH SLIDE STELLAR WITH SOFT CLOSE - 3 DOOR SET         |  | 25000 |
| HIWFSTRSTSC  | SMOOTH SLIDE STELLAR CENTRO SOFT CLOSE SYSTEM             |  | 2300  |
| HLWTSTLR24T  | SMOOTH SLIDE STELLAR SET OF TOP & BOTTOM TRACK 2.44m TWIN |  | 5175  |
| HLWTSTLR36T  | SMOOTH SLIDE STELLAR SET OF TOP & BOTTOM TRACK 3.66m TWIN |   | 7950  |







Toll-free number  
1800-2120-500



## **SLEEK INTERNATIONAL PVT. LTD.**

enquiry@sleekworld.com | www.sleekworld.com

Copyrights reserved. Sleek International Pvt. Ltd. 2014

"All the information and contents on the booklet/website/brochure/catalogue are owned and exclusive property of Sleek International Pvt. Ltd. is protected under the Copyrights Act, 1957 and the Copyright Laws of all other countries worldwide under the Berne Convention. All rights are reserved and no part of this booklet/website/brochure/catalogue shall be reproduced, stored in a retrieval system or transmitted in any form or by any means - electronic, magnetic tape, mechanical, printing, photocopying, recording or otherwise including the right of translating in any language without the prior written consent of Sleek International Pvt. Ltd."

02/2022 (Version 1.0)